

09.11.2009	09:00 – 17:47	Meeting room “Salon Macke” Hilton Park Munich	
	David Parish / GBR	DP	
	Il Hwan Kim / KOR	IK	
	Max Mückl / GER	MM	
	Pauline Pilkington / CAN	PP	
	Petros Kyritsis / CYP	PK	
excused	Fritz Schattleitner / AUT	FS	

Agenda

1	Welcome of members
2	Roll Call
3	Apologies for absence – Fritz Schattleitner excused
3.1	Nomination of recording secretary – Max Mueckl
4	Minutes of last meeting – no comments;
5	Matters arising from these minutes; there was a complaint from the Rifle Committee not to receive the Minutes 2008. But the ISSF HQ sent it out electronically and these Minutes were distributed in the ISSF Counsel Meeting 2008 in Beijing.
6	<p>Rifle</p> <p>Meeting of the ISSF Rifle Committee November 8th, 2009 09:00 hours Salon Marc of the Hotel (Mezzanine) November 9th, 2009 09:00 hours Hilton Munich Park Hotel A G E N D A (Minutes)</p> <p>1. Welcome Address Mr. Sepec, the Chairman opened the meeting at 09:00 hrs. Welcome address by the chairman of the Rifle Section Committee Mr. Tomislav Sepec. Mr. Sepec welcomed all the participants for their attendance</p> <p>2. Roll Call SEPEC, Tomislav Chairman of the ISSF Rifle Section Committee AHLSTEDT, Christina BRENCK, Ricardo GRILL, Wilhelm HAR-EVEN, Daphna HARRY, Allen W. MARANIK, Aado PAPAPANAGIOTOU, George ANDERSON, Gary (Part of 8th November) SCHREIBER, Horst. G. (Part of 8th November) SCHREIBER, Franz (Part of 8th November)</p> <p>3. Confirmation of the Minutes of the 2008 Meeting Matters arising:- No matters arising</p>

The Minutes were confirmed by consensus

4. Report about the activities since the last Committee Meeting

The Chairman has presented a comprehensive report, to the Administrative Council, Munich May 2009.

- The 75 minutes prior to the start of the Final, as determined at the 2008 meeting was considered to be sufficient;
- The consensus of the meeting is that the "shoot-off" is not the best method to determine who proceeds to the Final, the placing should be determined by "Inner Tens".

5. Report from the Technical Committee Chairman

- Mr. David Parish & Mr. Max Mueckl (from the Technical Committee) attended and presented a review of the decision from the 2008 Technical Committee Meeting, most proposals of the Rifle Committee were agreed to.

6. Proposals from Committee Members

AHLSTEDT, Christina

That the Organising Committee provides all the necessary equipment, for the functioning of the Equipment Control, a complete list of items, with photographs, is to be prepared, for distribution to Organising Committees.

Agreed by consensus.

See Rule 6.4.1

HARRY, Allen W.

Re the incidental touching of the hat on the rear sight, dependant upon the circumstance, whether deliberate or accidental, 7.5.1.1.7, 7.5.1.2.6, 7.5.1.3.8, what action is to be taken?

The opinion of the Committee is that the Jury, at the time, must determine if the "touching" is inadvertent and occasional or deliberate and regular and then take no action for the inadvertent and occasional occurrence or apply a warning if the decision is that the action is deliberate and regular.

HARRY, Allen W.

Proposal for the resolution of the clothing issue.

After discussion the Committee decided that the clothing issue should be approached from two directions;

What is able to be achieved immediately, at an acceptable cost,

What must be achieved in the future (next quadrennial).

The detailed proposal was moved towards the end of the meeting.

GRILL, Wilhelm

We should delete the pockets from the shooting jacket (lower price, less problems during Equipment checking and not even a lot of shooters are using the pocket).

The Committee resolved that the pocket should stay; the women shooters use the pocket.

Noted

Shooting Jackets:

Why the sleeves have not straight hanging down form, they have a curve form and it is like stabilizing (if a shooter needs more movement,

the material can be opened in little cutting forms),

The Committee resolved that this matter be included in the complete review of shooting clothing towards the end of the meeting.

Noted

Shooting Trousers:

All reinforcements must be taken away, for kneeling position a piece of material between the foot and back seat can be used (must be approved).

General Problems with Trousers

Seat pads too big, and waist band problems

This proposal was similar to the proposal from Aado Maranik.

Proposals for the future:

All new material must be approved first by ISSF rifle committee before it goes on the market.

The Committee resolved that this matter be included in the complete review of shooting clothing towards the end of the meeting.

New drawing for 2012 Rule book (for the shooting boot)

The Committee resolved that this matter be included in the complete review of shooting clothing towards the end of the meeting.

Clarification:

The new plastic material from Mouche does not comply with the ISSF regulations and brings up problems more and more:

Can be refused using 6.4.2.1.1

Too many seams and parts

Testing of Instruments in general and approving by the ISSF.

The Committee agreed with the three points.

Noted

MARANIK Aado

Change

7.4.6.2 All shooting jackets, shooting trousers and shooting gloves must be made of flexible material that does not materially change its physical characteristics, that is, become stiffer, thicker or harder, under commonly accepted shooting conditions. All lining, **and padding and reinforcements** must meet the same specifications. Any lining **or padding** must not be quilted, cross-stitched, glued or otherwise affixed to the outer clothing layer other than at normal tailoring points. All lining **or padding** must be measured as a part of the clothing.

Noted for Rule Book 2013 – bring it forward 2011

The Thickness table remove the 10.0 mm & 20 mm from the trousers column

7.4.6.4.1.1

Thickness – Table

	Jackets	Trousers	Shoes	Gloves	Under-wear
single thickness	2.5 mm	2.5 mm	4.0 mm	—	2.5 mm
double thickness	5.0 mm	5.0 mm	—	—	5.0 mm
total thickness	—	—	—	12.0 mm	—
Reinforcements	single thickness	10.0 mm	10.0 mm	—	—
Reinforcements	double thickness	20.0 mm	20.0 mm	—	—

Noted for Rule Book 2013 – bring it forward 2011

7.4.7.8 Shooting Trousers (change) - Clarification

7.4.7.8.1 The trousers, including the lining, must not exceed 2.5 mm in single thickness and 5 mm in double thickness at any point where flat surfaces may be measured. The top of the trousers must not fit or be worn higher on the body than 50 mm above the crest of the hipbone. All drawstrings, zippers or fasteners to tighten the trousers around the legs or hips are prohibited. To support the trousers only a normal waist belt not more than 40 mm wide and 3mm thick or braces (suspenders) may be worn. If a belt is worn in the standing position, the buckle or fastening must not be used to support the left arm or elbow. The belt must not be doubled, tripled etc. under the left arm or elbow. If the trousers have a waist band, it may not be more than 70 mm wide. If the thickness of the waistband exceeds 2.5 mm, a waist belt is not permitted. If a waist belt is not worn, the absolute maximum thickness of the waistband is 3.5 mm. Each belt loop (keeper) must not exceed 20 mm width. The trousers may be closed by one hook and up to five (5) eyes, or up to five (5) adjustable snap fasteners, or similar closure or Velcro (Hook & Loop but there may must only be one layer of Hook and one layer of Loop, when closed, the closure must not be multi layered). Only one type of closure is permitted. A Velcro (Hook and Loop) closure combined with any other closure is prohibited. The trousers must be loose around the legs. If special shooting trousers are not worn, ordinary trousers may be worn providing they do not give artificial support to any part of the body.

Change

7.4.7.8.2.3 **No** reinforcements may be added to the seat and both or knees of the trousers. ~~The seat patch must not exceed the width of the hips and the vertical measurement must not be longer than to cover the normal wear points on the seat of the wearer. Knee patches may have a maximum length of 300 mm. Knee reinforcements must not be wider than half the circumference of the trousers leg. The thickness of reinforcement including the trousers material and any linings must not exceed 10 mm in single thickness (20 mm double thickness).~~ All pockets are prohibited.

Noted for Rule Book 2013 – bring it forward 2011

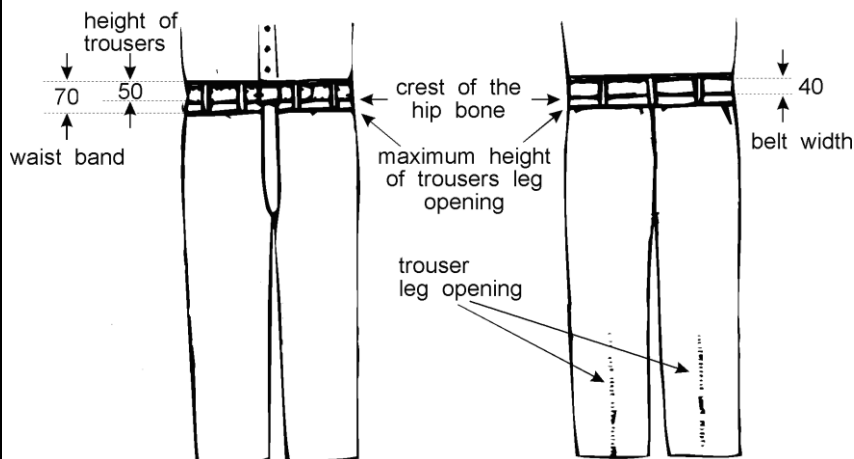
7.4.7.8.2.4

Noted for Rule Book 2013 – bring it forward 2011

7.5.1.3.13 Only the trousers and underclothing may be worn between the shooter's seat and heel. The jacket ~~or other articles~~ must not be placed between these two points or under the right knee. It is permitted to place a flat (not profiled) compressible pad (200 mm x 250 mm maximum width and length) in single thickness, between the heel and shooter's seat, as well as the shooter's knee and the ~~ground sheet~~ shooting mat, which when tested with the thickness testing device (7.4.6.4.1) shall not exceed 10mm in thickness, or when tested, for stiffness, with the device (7.4.6.4.2.1) shall have a depression of 3mm or more, or firing point surface.

Noted for Rule Book 2013 – bring it forward 2011

Shooting Shoes**7.4.6.3 Shooting Shoes**

Normal street type or light athletic shoes and specially manufactured single purpose shooting shoes not exceeding the following specifications are permitted in the kneeling position only;

Noted for Rule Book 2013 – bring it forward 2011

7.5.1.2 Standing

7.5.1.2.1 The shooter must stand free with both feet on the firing point surface or on the ~~ground cloth~~ shooting mat without any other support.

Clarification- goes to the Errata

7.4.6.3 ~~7.5.1.2.1~~ The shooter may wear normal street type or light athletic shoes, not higher than the ankle-bone; specially manufactured single purpose shooting shoes or boots are not permitted.

Noted for Rule Book 2013 – bring it forward 2011, but use the same wording as for pistol.

The committee agreed with this proposal, the rational being that the changes could be achieved quickly at a minimal cost, and it would go a long way towards the elimination of the "Penguin" parade, especially for Air Rifle shooters.

Noted for Rule Book 2013 – bring it forward 2011

The Committee also agreed that the changes take place from the 1st January, 2010.

Noted for Rule Book 2013 – bring it forward 2011

PAPAPANAGIOTOU, George

Kinesio Tape and sports taping

During the Milan 2009 WC there was a discussion among the jury members about Kinesio Tape or sports taping. I talked to the physiotherapist of the USA team and she was very kind to explain me what is Kinesio Tape and how it works. She also explained the traditional sports taping which is used to contract muscle movement. According to the lady Kinesio taping can be used either to enhance or to contract muscle movement. It doesn't immobilize the body part on which it is applied but we have to consider if it can be accepted during a shooting event.

Information can be found in the internet (<http://www.kinesiotaping.com>) or by googling the words kinesio tape or kinesio taping.

The following article is from the Canadian site for kinesio taping (<http://www.kinesiotape.ca>)

What does Kinesio Taping do.

Kinesio Taping gives support and stability to your joints and muscles without affecting circulation and range of motion. It is also used for Preventive Maintenance, Edema, and Pain Management.

Kinesio Taping is a technique based on the body's own natural healing process. This Kinesio Taping exhibits its efficacy through the activation of neurological and circulatory systems. This method basically stems from the science of Kinesiology, hence the name "Kinesio". Muscles are not only attributed to the movements of the body but also control the circulation of venous and lymph flows, body temperature, etc. Therefore, the failure of the muscles to function properly induces various kinds of symptoms.

Consequently, so much attention was given to the importance of muscle function that the idea of treating the muscles in order to activate the body's own healing process came about. Using an elastic tape, it was discovered that muscles and other tissues could be helped by outside assistance. Employment of Kinesio Taping creates a totally new approach to treating nerves, muscles, and organs. The first application of Kinesio Taping was for a patient with articular disorders.

For the first 10 years, orthopaedists, chiropractors, acupuncturists and other medical practitioners were the main users of Kinesio Taping. Soon thereafter, Kinesio Taping was used by the Japanese Olympic volleyball players and word quickly spread to other athletes. Today, Kinesio Taping is accepted by medical practitioners and athletes in Japan, United States, Europe, South America and other Asian countries.

The Kinesio Taping Method is applied over muscles to reduce pain and inflammation, relax overused tired muscles, and to support muscles in movement on a 24hr/day basis. It is non-restrictive type of taping which allows for full range of motion.

In contrast, traditional sports' taping is wrapped around a joint strictly for stabilization and support during a sporting event obstructing the flow of bodily fluids... an UNDESIRABLE side-effect.

Kinesio Tape is used for anything from headaches to foot problems and everything in between. Examples include: muscular facilitation or inhibition in paediatric patients, carpal tunnel syndrome, lower back strain/pain (subluxations, herniated disc), knee conditions, shoulder conditions, hamstring, groin injury, rotator cuff injury, whiplash, tennis elbow, plantar fasciitis, patella tracking, pre and post surgical edema, ankle sprains, athletic preventative injury method, and as a support method.

The consensus of the meeting was that it was against the "Spirit" of the ISSF Official Statutes, Rules and Regulations and, hence should not be permitted.

Noted – not allowed

PAPAPANAGIOTOU, George

The need for an internet based 'forum' and repository for the rifle committee members

There was a discussion this year among the Rifle Committee Members regarding certain Sauer shooting trousers. A lot of emails were exchanged and everybody was writing his/her opinion and/or commenting on the subject. The result was a whole pile of emails that nobody could arrange in a specific order and keep track of the situation.

At some time this year I needed the form we use for writing down the measurements during jacket and trousers control. I could not find it in my files so I looked at the ISSF site. It was impossible to find it either so I asked it from Willy.

My proposal is to have a small internet based 'forum' where only the rifle committee members will have access (for example by user name and password) and all subjects for discussion will be saved there in chronological order. A small internet database and some internet forms can achieve this. In this way everybody can see what the other members think about the subject and can write his/her opinion.

This 'forum' must also host all necessary forms and files. In this way we can find something we need when for example we are in a shooting event.

George to prepare a proposal to present to the ISSF.

Noted

HAR-EVEN, Daphna

Tie breaking "shoot-off" of 5 shots decimal, for unbreakable ties for medal placing, non-Olympic Events. See Rule 6.14.2.4

The consensus of the meeting was that the existing rules remain as written.

Noted

7. Clarification and discussions about the Rules for the Rifle Events

AHLSTEDT, Christina

Rule 7.5.1.2.4 is was agreed that the right hand may not touch the chest.

Not agreed

Rule 7.5.1.2.10, is was agreed that the right hand may not touch the chest.

Makes no sense

a. Clothing (for the period subsequent to London Olympic Games)

Discussions as below.

HARRY, Allen W.

Technical Rules for all Shooting Disciplines:

6.4.2.1.1 The use of any special devices means or garments which immobilize or unduly reduce the movement of the shooter's legs, body or arms is prohibited in order to ensure that the performance Skills of the shooters are not artificially improved by special clothing.

No change s/S ??

Rifle Rules:

“7.4.7.3 All straps, laces, bindings, seams, stitching or devices which may be construed as artificial support are prohibited.....”

“7.4.7.10.2 Only normal personal undergarments and/or training clothing that does not immobilize or unduly reduce the movement of the shooter’s legs, body or arms may be worn under the shooting Jacket and/or trousers. Any other undergarments are prohibited.”

No change seen

Proposed rules changes: These proposed changes will reduce the amount of thickness and stiffness of the shooting clothing, therefore reducing the amount of artificial support provided by the clothing.

7.4.6.2 All shooting jackets, shooting trousers and shooting gloves must be made of flexible material that does not materially change its physical characteristics, that is, become stiffer, thicker or harder, under commonly accepted shooting conditions. All lining, padding and reinforcements must meet the same specifications. Any lining or padding must not be quilted, cross-stitched, glued or otherwise affixed to the outer clothing layer other than at normal tailoring points. All lining or padding must be measured as a part of the clothing. **All clothing must be fabricated using canvas and leather as the basic materials. No plastic panels or plastic inserts are permitted.**

Not possible – find another wording for the plastic...

7.4.6.4.2.3 If a figure below 3.0 **4.0** is displayed the material is too stiff.

Noted for Rule Book 2013 – bring it forward 2011

7.4.6.3 Shooting Shoes

Normal street type or light athletic shoes, and shooting shoes not exceeding the following specifications are permitted:

7.4.6.3.1 The material of the upper part (above the line of the sole) must be of soft, flexible, pliable material, not thicker than 4 mm, including all linings, when measured on any flat surfaces such as point D in the Figure of the Shoe. **No removable inserts are permitted.**

Noted for Rule Book 2013 – bring it forward 2011

7.4.6.3.2 The sole must be flexible at the ball of the foot. **This must be demonstrated by manually flexing the shoe or walking in a normal heel-toe manner, at equipment inspection or when requested by a Jury member.**

Put in Guidelines

7.4.6.4.1.1 Thickness – Table

	Jackets	Trousers	Shoes	Gloves	Underwear
Single thickness	2.0 mm	2.0 mm	4.0 mm	—	2.0 mm
Double thickness	4.0 mm	4.0 mm	—	—	4.0 mm
Total thickness	—	—	—	12.0 mm	—
Reinforcements					
single thickness	8.0 mm	8.0 mm	—	—	—
Reinforcements					
double thickness	16.0mm	16.0 mm	—	—	—

Noted for Rule Book 2013 – bring it forward 2011

7.4.7.8 Shooting Trousers

7.4.7.8.1 The trousers, including the lining, must not exceed 2.5 mm **2.0 mm** in single thickness and 5 mm **4.0 mm** in double thickness at any point

where flat surfaces may be measured. The top of the trousers must not fit or be worn higher on the body than 50 mm above the crest of the hipbone. All drawstrings, zippers or fasteners to tighten the trousers around the legs or hips are prohibited. To support the trousers only a normal waist belt not more than 40 mm wide and 3 mm thick or braces (suspenders) may be worn. If a belt is worn in the standing position, the buckle or fastening must not be used to support the left arm or elbow. The belt must not be doubled, tripled. Under the left arm or elbow. If the trousers have a waist band, it may not be more than 70 mm wide. If the thickness of the waistband exceeds 2.5 mm **2.0 mm**, a waist belt is not permitted. If waist belt is not worn, the absolute maximum thickness of the waistband is 3.5 mm **3.0 mm**. Each belt loop (keeper) must not exceed 20 mm width. The trousers may be closed by one hook and up to five (5) eyes, or up to five (5) adjustable snap fasteners, or similar closure or Velcro. Only one type of closure is permitted. A Velcro closure combined with any other closure is prohibited. The trousers must be loose around the legs. If special shooting trousers are not worn, ordinary trousers may be worn providing they do not give artificial support to any part of the body.

Noted for Rule Book 2013 – bring it forward 2011

7.4.7 Shooting Jacket

7.4.7.1 The body and sleeves of the jacket, including the lining, must not exceed 2.5 mm **2.0 mm** in single thickness and 5 mm **4.0 mm** in double thickness at any point where flat surfaces may be measured. The jacket must not be longer than the bottom of the balled fist (see Jacket Table).

7.4.7.2 Closure of the jacket must be only by non-adjustable means e.g. buttons or zippers. The jacket must not overlap more than 100 mm at the closure (see Jacket Table). The jacket must hang loosely on the wearer. To determine this, the jacket must be capable of being overlapped beyond the normal closure by at least 70 mm, measured from the centre of the button to the outside edge of the button hole. The measurement will be taken with the arms at the sides. A measurement may be made either manually or with an ISSF approved overlap gauge with a tension of 6 kg to 8 kg. The area surrounding the button hole is limited to a maximum of 12 mm, and this area may exceed the permitted 2.5 mm **2.0 mm** thickness.

Noted for Rule Book 2013 – bring it forward 2011

7.4.7.4 The construction of the back panel may include more than one-piece of material provided that this construction does not stiffen or reduce the flexibility of the jacket. All parts of the back panel must comply with the thickness limit of 2.5 mm **2.0 mm** when measured over a flat surface. All parts must comply with the stiffness limit.

Noted for Rule Book 2013 – bring it forward 2011

7.4.7.7.1 Maximum thickness, including jacket material and all linings: 10 mm **8 mm** single thickness or 20 mm **16 mm** when measured as a double thickness.

Noted for Rule Book 2013 – bring it forward 2011

7.4.7.10 Dressing the Shooter

7.4.7.10.1 Clothing worn under the shooting jacket must not be thicker than 2.5 mm **2.0 mm** single thickness or 5 mm **4 mm** double thickness. The same applies to all clothing worn under the trousers.

b. Equipment

- Technical Committee presented a picture of an air rifle that had the dimension "D" rule 7.4.2.6 & 7.4.2.7 Table, increased to the maximum permitted (90mm) dimension, by the addition of an attachable block, that does not appear to be orthopaedially formed. The Committee voted on the matter and a majority decided that it would be permitted. The range Jury has the duty to ensure that this type of addition to the depth of the Forend is not used as a hand-stop.



Pictures are Rules!
 Where figures and tables contain specific information, these have the same authority as the numbered rules.
 See 7.4.2.6
 The Rifle Committee should consider the matter again

c. Rifles

Grunning & Elimger, straight **through pull** bolt, is difficult to see if the action is open. Test plug should be used.

The open chamber is visible

d. Testing devices and instruments

New Template Rifle laminated paper architecturally printed is approved by the Committee.

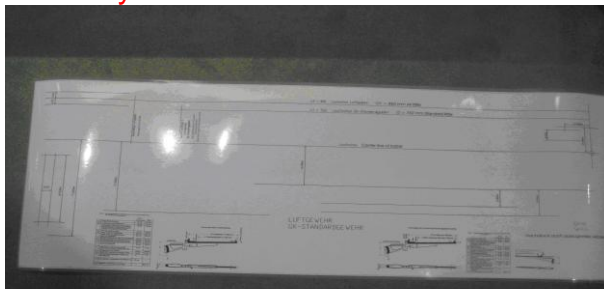

Board template (by TEC-HRO) with pins is approved by the Committee.

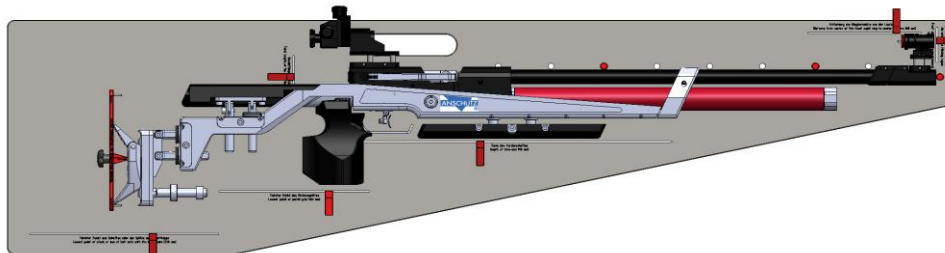

Jacket Overlap gauge (manufacturer PRECISE by Schaefer), smaller for C of EC use on the range.

The Committee is not entitled to approve items.
The correct procedure is to apply to the ISSF HQ by sending a sample and a written application.

e. Equipment control

Equipment that is required for an ISSF World Cup:-

- Stiffness tester
- Thickness tester
- Boot Ratio Gauge
- Templates and drawings (Rifle and Pistol)
- Guidelines Equipment Control Rifle & Pistol
- ISSF Sponsorship Rules
- Overlap gauge (6kg to 8kg pull force)
- Pistol boxes (2 sizes)
- Trigger weight 500gm & 1000gm, (three sets trigger testing weights 10m range, 25m range and EC area)
- Electronic scales 10kg & 5kg (one (1) gram steps)
- Equipment Control Stickers
- Equipment Control Forms Rifle, Pistol.
- Notification cards for random testing rifle and pistol.
- Red, Green and Yellow cards for Juries.
- Suitably sized ring folders for filing forms.
- Two hole punches, staplers, pens & pencils.
- ISSF Seals
- Rivets
- Hole punch(s)
- Support block for the punch.
- Hammer
- Cutting tools, knife, scissors
- Computer
- Printer
- Laminator
- Paper cutter
- Stable furniture (tables, chairs)

Put in Guidelines

8. Some problems at the international competitions in 2009

a) R E P O R T FROM THE EUROPEAN CHAMPIONSHIPS – EPSO 2009 Osijek, 12 – 26 July 2009

The organiser had to face a whole range of difficulties in preparation and arrangement of the shooting range for the European Championships.

The local government in the city of Osijek changed four times in two years, always coming up with new political options and constant postponing of provision of funds for the reconstruction and refurbishment of the facilities at the Pampas shooting range. Global recession had a considerable impact on the course of preparations.

Finally, the funds were provided the shooting range was completely reconstructed and five ranges for shotgun events, equipped with Mattarelli devices, were made.

A notable contribution to the finishing of all works on the facilities was given by the Croatian Army, whose manpower and technical equipment was

used at the Pampas shooting range for more than seven months.

Thanks to a large number of involved professionals and judges (more than 380 in total), the Championships was organised and conducted in a professional and efficient way.

Special thanks go to the Technical Delegate Mr Max Mückl, jury members and over 70 judges with the international judges' licence for the excellent conduct of the Championships.

The conditions at the shooting range, both technical and atmospheric, enabled excellent conduct of the event, at which:

- ✚ 4 new world records were established and 3 world records were equalled;
- ✚ 4 new European records were established and 3 European records were equalled.

The Championships was held in 37 (disciplines) events, with the participation of 995 shooters and 1,412 starts.

The competitors came from 44 national shooting federations from 43 European countries.

Medals were won by representatives of 27 countries:

Total number of medals	219
Gold	73
Silver	73
Bronze	73

Before the Championships in Osijek, the Election General Assembly of the ESC was held. The new Presidium of the ESC was elected for a term of office of next four years, with Mr Vladimir Lisin of Russia at the position of the President.

Accommodation and transfers were well organised, especially the transfers Zagreb – Osijek, which was flawless. In 23 days, a large number of buses, vans and personal cars made a total of 125,647 kilometres in transfers of the Assembly delegates, competitors, coaches and members of the jury.

However, we should say that there were some remarks and complaints about the shooting range premises, changing of shooters' clothes on the shooting line and keeping the entire equipment in the shooting space, so that the new President Mr Vladimir Lisin concluded that new and better solutions should be found, especially in the women's part of the event.

Finally, the Championships was closed with a dispute with the organiser, which refused to pay to the ISSF the newly established fee of EUR 5.00 for each start at the Championships, due to the earlier signed agreement.

With regard to the new ISSF Rules adopted at the ISSF Assembly in Beijing in April 2008, the Republic Shooting Council of the Croatian Shooting

Federation decided that the Croatian Shooting Federation would take over that liability and make a corresponding payment.

TOMISLAV SEPEC

Noted

b) Conclusions from the Report to the Organisers Meeting November 6 & 7 2009

- good preparation of the Organising Committee with regard to all organisational and technical elements;
- strict adherence to all ISSF Rules;
- direct and constant collaboration with the Technical Delegate of the event;
- timely testing of all technical elements enabling successful organisation of the event;
- training, specialisation and testing of technical personnel and judges;
- timely informing of jury members on arrival, accommodation and duties;
- the entire personnel should be present at the shooting range during the whole event, checking and leading the preparations, trainings and competition, always in accordance with the ISSF Rules and safety measures;
- direct collaboration among technical personnel, judges, range officers and jury members;
- All forms and documents must be at the shooting range, i.e. at the chief range officer during the event, so that all incidents, delays and appeals could be instantly solved.
- Greater emphasis be placed on the appointment of the Host Nation Jury & CRO that have English language skills (or have sport specific interpreters available) to carry out their tasks efficiently

Noted

9. Appointments of the Juries for the 2010 World Cups

World Cup Jury 2010

According to our contacts and discussions, here is my proposal for the Rifle Jury and Equipment Control Jury members for the World Cups in 2010:

- | | | |
|-----------------------------------|------------------------|----------------------|
| 1. Sidney, 19.03.-28.03.2010. | Rifle Jury | Christina Ahlstedt |
| | Equipment Control Jury | Wilhelm Grill |
| 2. Beijing, 15.04.-25.04.2010. | Rifle Jury | George Papapanagiotu |
| | Equipment Control Jury | Aado Maranik |
| 3. Ft Benning, 22.05.-31.05.2010. | Rifle Jury | Daphna Har-Even |
| | Equipment Control Jury | George Papapanagiotu |
| 4. Belgrade, 23.06.-30.06.2010. | Rifle Jury | Harry Allen |
| | Equipment Control Jury | Wilhelm Grill |

Spare member: Ricardo Brenck

Noted

10. Miscellaneous

- a) **The Committee considered the document provided "First Errata for ISSF Rules and Regulations" Edition 2009 (First printing 11/2008)**

Noted

Application for Judge's License Renewal That **"as a jury member" replace the words "as a shotgun referee"**

Agreed

Noted

ISSF Eligibility Rules

4.4.2.2 On the front / rear sight blinders no manufacturer or sponsor identification is permitted.

Agreed

Noted

Table 1 page 124 of Rule Book **Not agreed, it is not page 124**
typing mistake page 121

ISSF Anti-Doping Regulations

6.6.4.3.1 After receipt of two(2) formal written warnings from ISSF or an ISSF Member Federation, any Shooter in the ISSF Registered Testing Pool who fails to submit timely whereabouts report when required to do so, in the preceding eighteen (18) months will be considered to have committed an anti-doping rule violation pursuant to Article 5.3.4.

Agreed

Noted

Technical Rules for all Shooting Disciplines

6.1.4 Knowledge of the Rules

All shooters, team leaders and officials must be familiar with the ISSF Rules and must ensure that these Rules are enforced. It is the responsibility of each shooter to comply with the Rules.

Renumber old 6.1.4 to 6.1.4.1 and old 6.1.4.1 to 6.1.4.2 and delete 6.10.2.1

Agreed

Noted

6.3.3 Paper Sighting Targets

Sighting targets must be marked clearly with a black diagonal stripe in the upper right hand corner of the target. The stripe must be clearly visible to the naked eye at the appropriate distance under normal light conditions (except for the 25 m Rapid Fire Pistol Target and the 50 m Running Target).

Agreed

Noted

6.3.4.4 Backing Cards – Electronic Scoring Targets 10 m/ 50 m/ 300m

A Backing Card must be affixed to the rear of the target which must be renewed for each relay and in 50 m and 300 m Rifle 3 Positions Men for each position unless a Control Sheet is used. (except at 10 m when a black paper strip is used).

Agreed

Noted

6.3.8.4 The firing line must be clearly marked. The range distance must be measured from the target line to the edge of the firing line nearest to the shooter. The use of a board as a firing line is not permitted. The competitor's foot or, in the prone position the competitor's elbow may not be placed on or in front of the firing line.

Agreed

Noted

25 m Pistol and 25 m Center Fire Pistol Rapid Fire Stage:
facing for three (3) seconds for each shot, alternating with an edge-on face
away time of seven (7) seconds (± 0.1 second);

No opinion

Noted

6.3.19.4 The traps must be released by an electric-manual or electric-microphone system. The control system must be placed in such a position that the puller can clearly see and hear the call of the shooter. The release devices must guarantee equal distribution of targets to each shooter in a series of 25 targets. This distribution must be: 10 targets to the right, 10 targets to the left and 5 targets to the centre. With the correct distribution, in a series of 25 targets, each group of traps must throw two targets from the left trap, two from the right trap and one from the centre trap as the shooters progress from station 1 to 5. After every five (5) targets the selector index must be advanced one step.

No opinion

Noted

6.3.22.3.3 Targets properly released must pass through a circle 0.9 m – 0.95 m in diameter, located 4.60 m +/-0.05 m above the Center point.

No opinion

Noted

6.5.4.9.1 (Pistol Committee) Need new wording regarding last relay of second stage The second 30 shot stage must begin only after all shooters have completed the first 30 shot stage. If there are fewer shooters than are necessary to completely fill all relays in the first stage, then the gaps must be left in the last relay of the first stage.

No opinion

Noted

6.6.2.3 The Juries must supervise the examination of the guns, equipment, and accessories (in the Equipment Control Section), and continuously observe the shooting positions and the equipment of the shooters.

Agreed

Noted

6.8.15 All irregularities, penalties, misses, malfunctions, extra time allowed, repeated shots / series or annulment of shots, etc., must be clearly marked and recorded on a Range Incident Report Form IR (see form at the end of these Rules), the Range Register, printer strip, on the target and on the score card (paper target) by a Range Officer and/or Jury Member for the attention of the Classification Office.

No opinion

Noted

6.10.6.3.1 In the case of a disqualification in the Finals the shooter will be ranked on the last place of the participating finalists, but may retain his Qualification score including any shoot-off before the Finals.

Agreed

Noted

6.11.5.2 If a shooter is interrupted for more than five (5) minutes, or moved to another firing point, he may have additional unlimited sighting shots at one sighting target at the beginning of his remaining shooting time together with any time extension granted plus an additional five (5) minutes. If automatic paper target systems which have no possibility for providing a new sighting target are in use, the sighting shots should be fired on the next unused competition target. Two (2) competition shots (10 competition shots in the 50 m Pistol Men's event) should be fired at the next competition target according to the instructions given by the Range officials or Jury Members. Range officials or Jury Members must

ensure that a complete explanation is recorded on the score sheet, and on a Range Incident Report.

Agreed

Noted

6.13 FAILURE OF ELECTRONIC SCORING TARGET SYSTEMS -10 m, 50m AND 300 m

Agreed

Noted

6.13.3 Procedure of the failure of a SINGLE target in 10 m, 50 m and 300 m Events

Agreed

Noted

6.13.3.1 If the Electronic Scoring Target cannot be repaired within five (5) minutes, the shooter will be moved to a reserve position and when he is ready to shoot an additional five (5) minutes will be added to the competition time remaining. He will be permitted unlimited sighting shots before he starts the remaining competition shots.

Agreed

Noted

6.14.6.4 In the 10 m and 50 m Events a Preparation and Sighting period of five (5) minutes will be given followed by five (5) shots (decimal scoring) on command in the relevant Finals position in 75 seconds (prone 45 seconds) per shot. If there is still a tie, it will be decided shot by shot until every tie is broken.

Agreed

Noted

6.14.6.5 Rules for Shoot-offs in all 25 m events (full ring scoring) Shooters tied will be allocated new firing points on the Qualification range by drawing of lots by the Jury. If more shooters are tied than target groups are available, the firing sequence will also be determined by drawing of lots.

No opinion

Noted

6.15.4.2.3 If the protest concerning a shot value, other than zero or failure to register, is not upheld, a two (2) point penalty from the score of the disputed shot will be awarded and the protest fee must be paid.

Agreed

Noted

6.16.4.3.5 The discharge of gas in air guns is not permitted; two (2) points will be deducted from the first Finals shot.

Agreed

Noted

6.16.6.5.4 For tied scores all tied shooters will be ranked according to the TIE-BREAKING Rules. If it is still a tie the better or best Finals result will be used to break the tie.

Noted

Agreed

Rifle Rules

7.4.3.2 Butt plate and Hook Correction of drawing only

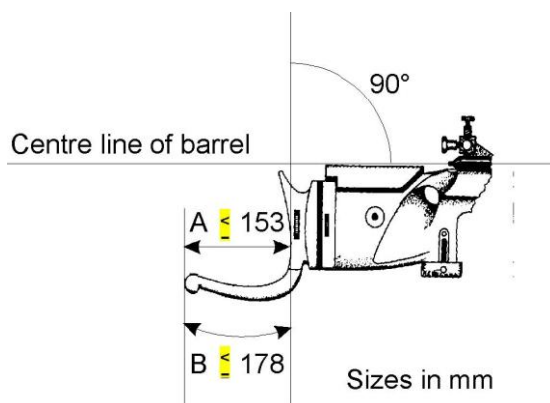

Agreed

Noted

To 7.4.7.6 (Rifle Committee). This text needs correction regarding yellow see also 6.3.6.3.5 where no penalty for floor is mentioned. Also why only 2 points deduction because of concealed rule violation and unsportsmanlike behaviour.

7.4.7.6 No Velcro, sticky substance, liquid, or spray may be applied to the outside or inside of the jacket, pads or shoes and/or floor or equipment. A deduction of two (2) points will be given for the first offence and a further violation may involve disqualification. Roughening the material of the jacket is permitted.

The yellow marked text goes out. The rules for all disciplines are now the same. 6.10.6.5.1 and 6.10.6.5.2 cover everything

Rule 6.3.6.3.5 is the change required, as they read now only Rifle has a penalty imposed. If a penalty is to be imposed then it must be for all, Rifle, Pistol, Running Target and Shotgun should have equal treatment.

6.3.6.3.5

It is prohibited to put any sticky substance, liquid, or spray on the floor of the Firing Point.

It is prohibited to wipe the firing point without permission.

A deduction of two (2) points will be given (from the value of the first shot or series) for the first offence and a further violation may involve disqualification.

Then also the Rifle Rules change to:-

7.4.7.6 No Velcro, sticky substance, liquid, or spray may be applied to the outside or inside of the jacket, pads, shoes or equipment. Roughening the material of the jacket is permitted.

No need to alter other rules. 6.10.6.5.1 and 6.10.6.5.2 cover everything

7.5.1.2.10 the right hand may not touch the left hand, left arm or the left sleeve of the shooting jacket.

Agreed

Noted

7.5.1.2.10 the right hand may not touch the left hand, left arm or the left sleeve of the shooting jacket or sling.

Agreed

Errata_sheet_E_09.doc/11/8/2009 7:35:00 AM

Noted

b) NEW Final Proposed Willi Grill

8 shooters build 4 pairs all pairs are nominated and decided by drawing of lot.
The Qualification round results will be deleted.
2 minutes preparation time for all shooters, during this time unlimited sighting shots are allowed.
Scoring will be in decimal scoring, the maximum is 3 shots in qualification rounds, and 5 shots in the finals, one by one on command,
We always give points for the best shot, example: 10, 1 or 10, 4, the shooters with 10, 4 get the point
If a shooter has already 2 points out of 3 we will stop this pair, and this shooter can go forward to the next round, because the other can not win anymore.
If one shooter from the pair does not appear for the competition, then automatically the other shooter is considered to be the winner and will go on for the next round.
In case of any tie, a shoot off will decide it, all pairs will fire at the same time until the tie is broken.
The time limit per shot is 45 seconds, in shoot off too.
The system is in Knock Out (KO), so at the end of each round 4 shooters will go forward to the next round.
After all shooters have fired the first round, the winners for the next round will go on without preparation time and sighting shots.
After each round, a new drawing by lot will be done, so that the new pairs are built, and this will go on until the last 2 pairs.
After each round the previous points will be deleted, and the shooters start from zero (0) points. Shooting Time 30 seconds

Final:**Pair 1****Pair 2**

The same procedure like the last qualification round , but with less competition shots, (three shots) will take place and the losers from the two (2) pairs will shoot for place three (3) and four (4), and the winners will shoot for place one (1) and two (2).

Presentation to the spectators with a diagram, like biathlon, IN or OUT.

In other sports they play for place 4 and 3, and the place 1 and 2 as the highlight.

Shooting positions

10m AR in standing

Prone in prone

3x40 in kneeling

3x20 in kneeling

The same procedure can be used in all pistol events too.

c) Finals Format Proposed Allen W. Harry

Proposal for a new format for finals in all 10m and 50m precision events.

Eight finalists select in accordance with current rules.

Report time is still 20 minutes prior to finals "Start"

Finalists are ranked in accordance with their placement after qualification

Two minute preparation time

Three minute sighting time

30 Second pause to configure targets

All finalists will fire five shots in five minutes. Scoring will be the total of all 5

shots, decimal value.
 Lowest four totals will be dropped from continuing
 Remaining four finalists will fire one shot, 1 minute time limit
 Lowest score will be eliminated
 If tied for the lowest score, all will move forward
 Remaining three (or more) will fire another shot, 1 minute time limit
 Lowest score will be eliminated. All ties for will advance.
 Medal standing will be determined by sudden death shoot off, 1 minute per shot, until all medals are determined and all ties have been resolved.

7

Pistol

DATE:	TIME:	PLACE:
November 8 th , 2009	09:00 hours	Hilton Munich
November 9 th , 2009	09:00 hours	Park Hotel, Germany

Members present:

Susan B. Abbott	USA - Chairman
Alfredo Lalia Filho	BRA
Ki Rim Park	KOR
Ursula Staeuble	SUI
Milan Suva	CZE
Manfred Woelke	GER

Members absent:

Douglas Glaister	GBR
Wlodzimierz Sklenarski	POL

1. Welcome

Committee Chairman, Mrs. Susan Abbott opened the meeting, welcomed the Members and specially Alfredo, who has attend the meeting for the first time. She also mentioned regrets sent in by the Members who were absent. The Roll call is attached to the minutes (see annex 1).

2. Nomination of Recording Secretary

Ursula Staeuble was elected as Secretary of the Committee.

3. Review of minutes of last meeting

No comments to the Pistol Minutes 2008. The minutes were approved.

4.0 Rules – 2009 Rule Book**4.1 Shoot-offs – Rule 6.14.6**

After a short discussion we decided that there was no need for clarification.

4.2.1 Exchange of Pistol

In the former Rule Book there was the following rule:

Rule 8.4.1.1.1: The Shooter must use the same pistol in all stages and series of an event unless it ceases to function. This Rule should be added in the new Rule Book with the appropriate number.

Done 8.4.2**4.2.2 Measuring the Weight of the Trigger Pull – Rule 8.4.1.6.1**

The old text should be replaced by the following new text:

A weight with a metal or rubber knife-edge or a round configuration with rubber must be used. A roller on the **test trigger** weight is not permitted. A dead weight must be used with no springs or other devices. The headline of the first drawing will be enlarged to metal or rubber

knife-edge

and in the drawing the word metal will be deleted.

The second drawing will be changed. The rough draft is attached at annex 2 and the final drawing will be forward to Mr David Parish.

Done

- 4.3 **Preparation Time 25m Events** - Rule 8.6.4.1.1 and Rule 8.6.4.1.2
After a short discussion we decided there was no need for clarification.

4.4 **Duplication of language**

Suggestions for additions and/or clarifications

- 4.4.1 We won't change the context of the following rules but the words/content should be written in one table. It's easier to read. These changes should be done in the new Rule Book in 2013.

Rule 8.6.4.3.4.2 and 8.6.4.3.5 will be combined in one table

Rule 8.6.4.5.2 and 8.6.4.5.3 will be combined in one table

Noted

- 4.4.2 Rule 8.6.6.1.1.3

In this Rule the following sentence should be added:

This penalty is in addition to the penalty of two (2) points that may be imposed when a shooter loads more than five (5) cartridges

Done

- 4.4.3 Rule 8.6.4.4.3.2

The first letter should be a capital letter.

Noted

- 4.4.4 Rule 6.9.1.2.2 the last sentence should be changed into
"The Register Keeper records the values of the bullet holes on the score card (or individual scoreboard)."

Done

- 4.4.5 Rule 6.11.5.2 - the following sentence should be changed to make it clearer for 50m Pistol

Old version: Two (2) competition shots....

New version: The remaining competition shots will be shot on the next competition targets according to the instructions....

Done

- 4.4.6 Rule 6.11.5.3 the last sentence of Rule 6.11.5.2 should be deleted and replaced by the language of Rule 6.11.5.3.

Done

- 4.4.7 Rule 8.6.4.4.3.1

This rule is already corrected.

- 4.4.8 Rule 8.7.4.3.1.8

This rule can be removed because the content is already in the Rule 8.7.4.3.1.5 and Rule 8.7.4.3.1.4.

Done

- 4.4.9 Rule 8.6.8.1

New wording: If it is found that his claim is justified, he may begin the series again.

Done

- 4.4.10 Rule 6.3.15.1.1 The last sentence should be removed because it applies to all pistol ranges and has already been mentioned in the Rule 6.3.8.4.

- 4.4.11 It is the current practice not to patch or repair targets during the finals between relays of Rapid Fire Pistol, however no rule exists at the moment. In the Rule Book of 2013 this rule should be included stating

same.

Done for the present rules

Inputs of the Technical Committee:

4.4.12 Rule 4.4.2.2

On the front / rear sight blinders no manufacturer or sponsor identification is permitted. It was unclear to the Pistol Committee Members where the location of the rear "sight" blinders was. We recommend to the Technical Committee reword this.

Stay at it is

4.4.13 Rule 6.1.4

The Pistol Committee agreed on this change.

4.4.14 Rule 6.3.16.10.3

The Pistol Committee agreed on this change.

4.4.15 Rule 6.5.4.9.1

New wording:

The second 30 shot stage must begin only after all shooters have completed the first 30 shot stage. If there are fewer shooters than are necessary to completely fill all relays than gaps must be left in the last relay of the first stage and in the last relay of the second stage when the event is held over two (2) days.

Amended by the Technical Committee.

4.4.16 Rule 6.6.2.3

In this rule the highlighted proposal "in the Equipment Control Section" should be eliminated, since it is already mentioned in the Rule 6.4.4

Stay at it is

4.4.17 Rule 6.8.15

The Pistol Committee agreed on this additional input.

4.4.18 Rule 6.10.6.3.1

The Pistol Committee opines that this additional input is not needed.

Stay at it is

4.4.19 Rule 6.13.3.1

The Pistol Committee agreed on this additional input.

4.4.20 Rule 6.14.6.4

The Pistol Committee agreed on this additional input.

4.4.21 Rule 6.15.4.2.3

The Pistol Committee agreed on this additional input.

4.4.22 Rule 6.16.4.3.5

The Pistol Committee agreed on this additional input.

4.4.23 Rule 6.16.6.5.4

The additional sentence should be:

If there is still a tie the *best* Finals result will be used to break the tie.

Stay at it is

4.4.24 Check of the index

Everything is ok.

4.4.25 Rule 8.6.4.4.3.1

The Pistol Committee agreed on this change.

4.4.26 Rule 8.6.6.4

The Pistol Committee agreed on this change.

4.4.27 Rule 8.7.4.5.2.2.2

The Pistol Committee agreed on this change.

4.4.28 Malfunctions

At the November 2008 meeting of the Pistol Committee Mr Max Mueckl

advised the members that the 2009 version of the rules was incorrect as to the number of malfunctions allowed and that the Technical Committee would amend the language to state that a competitor could claim only one malfunction either an allowable or non/allowable malfunction. The Errata presented by the Technical Committee did not include the amended language.

Members of the Pistol Committee prefer the wording as it is in the current Rule Book.

8.7 MALFUNCTIONS

Only one (1) malfunction (either allowable or non allowable) is permitted except when stipulated in a specific event.

5.0 Clothing

5.1 Competitor

No additional inputs to this subject.

6.0 Handbook for Judges and Range Officers

Each Member of the Pistol Committee were assigned various sections to review and will send the reviewed document by the end of the year to Susan Abbott.

7.0 Guidelines for Uniform Equipment Control for Pistol

This point was discussed together with point 6.0.

8.0 Miscellaneous

8.1 Mr Horst Schreiber and Mr Franz Schreiber visited the Committee and gave us the task to bring in new ideas for the Finals in each discipline. The Members will discuss this point with coaches and shooters and will send their inputs to Susan Abbott.

8.2 Minutes of the Technical Committee 2008

Susan has informed the Members of the Pistol Committee about the decisions of the Technical Committee related to Pistol.

8.3 The Pistol Committee addresses were corrected and given to Mr Franz Schreiber.

8.4 It is the opinion of the Pistol Committee believes that it is an unfair advantage for the shooters to use an electronic trigger by clicking (dry firing) during the Final.

Noted

The meeting was adjourned at 13.50 h.

Respectfully submitted,
Ursula Staeuble, Secretary
Susan B. Abbott, Chairman

8

Shotgun

ISSF SHOTGUN COMMITTEE

**Minutes of the meeting held at the
Hilton Hotel**

Munich, Germany on

Sunday/Monday 8th and 9th November 2009

Present:

Chairman:	Mr.	Demetris LORDOS	CYP
	Mr.	Bhatakarka BUNNAG	THA
	Mrs	Elaine FORWARD	AUS
	Mr.	Daniele GHELFI	ITA
	Mr.	James McDANIEL	USA
	Mr.	Keith MURRAY	GBR

Mr. Mohamed WAHDAN EGY

present: (*part time*) Mr. Horst SCHREIBER Secretary-General ISSF
 Mr. Gary ANDERSON Vice-President ISSF
 Mr. Franz SCHREIBER Executive Director ISSF
 Mr. David PARISH Chairman ISSF Technical Committee
 Mr. Petros KYRITSIS Member ISSF Technical Committee
 Mr. Max MUCKL Member ISSF Technical Committee

1. Chairman:

The Chairman welcomed everybody and thanked all the members of the Shotgun Committee for their dedication and hard work during their appointment in any position in any ISSF supervised competition in the last year, and opened the meeting at 09.00 am expressing the hope that the meeting would be successful.

2. Apologies for Absence:

The Chairman announced that Mr. Anastasios Kastanis sincerely apologised for not being able to attend the meeting, due to a serious operation his father had to undergo lately, and his presence next to his father was more than necessary.

3. Matters Arising from the Previous Meeting:

None not otherwise listed on the Agenda.

4. Events for Juniors and Veterans: (pm 17d):

The possibility of having prestigious events for both Juniors and Veterans was discussed. Particularly in the first 2 years after the year of an Olympic Games.

After considerable discussion it was agreed that this should be tried.

It was noted that the term "World Cup" for these events would not be possible.

Noted

5. Double Trap, Reduction in Numbers:

Trials of an amended version of DT are taking place in Italy. viz:-

4 x rounds of 30 targets + Final = 150 targets as at present in Trap and Skeet.

Costs reduced to same as Trap and Skeet

Course of fire: 5 x scheme "A"

5 x scheme "B"

5 x scheme "C"

+ 1 x round of new scheme "D" (random 1 x double "A", 1 x double "B"

1 x double "C"

No timer

Discussion followed, members were urged to try this in their own countries and

report back to a meeting at the WCH in July.

Noted with interest Test in Lonato

6. Finals for Juniors in World Championships:

This was discussed at great length. All members being in favour.

In later discussion with the Secretary- General, the submission was denied.

Noted

7. Skeet Target Crossing Point: (see Annex "A")

It was agreed that a "step-by-step" method of skeet target setting be constructed.

In calm conditions-

Targets to cross at the centre of the ring (tolerance -15cm)

HIGH target to pass through top third of ring and travel 66m

LOW target to pass below the HIGH target

In adverse conditions an "average" of the settings be taken

Noted – put it to the Guidelines and TD Checklist

8. Trap & Double Trap 3.5m Targets.(pm 2b):

The Committee agreed that the following be re-submitted:-

" a proposal be made to the ISSF Technical Committee to reduce the maximum height of targets for Trap to 3.0m in order to minimise lead fall-out areas."

It was also agreed that the tolerance of 0.5m be amended to be 0.1m

Rule change for 2013

Noted for Rule Book 2013 – bring it forward 2011

9. Olympic Games Quota Places (pm 2c):

The Committee also agreed to re-submit the same proposal as in 2008:-

" The Committee proposed that where a tie for an Olympic Games Quota Place (QP) exists outside the top six (6) shooters, then any such tie must be broken by a shoot-off and not by the Count Back Rule." This being more fair.

The Committee was later informed that this would not be possible.

Noted

10. Breakability of Clay Targets:

The poor quality of Flash target "breaks" in Beijing once again highlighted the problem of there being no published standards for determining a suitable range over which the "breakability of targets can be measured.

The committee decided to attempt to design a suitable gauge to overcome this problem. Samples were to be requested from LaPorte and other companies to be sent to Munich for testing. Mr. Willi Grill offered to help.

Noted

11. Eyesight and Hearing Protection:

The Committee expressed concern over the implications of shooters, coaches and spectators not wearing adequate protection. *Rule change for 2013*

Noted but it can not be mandatory

12. Fragments of a Target (S9.6.14.14.3):

It was noted that the limitation of 2 occurrences was incorrect.

To be corrected. (Technical Committee are aware).

Already done in Errata

13. Non-Verbal Coaching:

The Committee agreed that non-verbal coaching should be permitted as now it is done and very difficult to be controlled.

Not agreed – see 6.10.5

14. "Make-up" Rounds:

After some discussion it was agreed that a make-up round should **if possible** be shot on the same range as the one he had to leave.

The Jury would decide on the range to be used if this was not practicable.

"If possible" goes to the Errata and complies to Rule 9.8.6 and 9.13.4.4

15. Item deleted.

16. Shooting in the Wrong Order:

It was agreed that this be referred to the list of rules to be formulated in Munich in August 2010. see Annex "C"

Noted

17. Skeet Marker Tape:

A method of correctly fixing the skeet marker tape was submitted by Mr. MacDaniel.

see Annex "B". It was decided that the document should be available on the ISSF website.

Agreed to be included in the Guidelines

18. Target Setting:

It was agreed that the committee should produce a "step-by-step" method of setting targets for Trap, Double Trap, and Skeet.

To be completed in Munich in 2010.

Noted

19. Double Trap "Sporting" Alternative:

It was finally decided that this alternative be re-considered in Munich.

Noted

20. Random Equipment Control:

Already within the scope of the present rules and therefore could be instituted.

Agreed

21. Shooter's Preparation Time:

After discussion it was agreed that shooters and Referees would be informed of the required time limitations.

Noted

22 Ported Barrels:

The necessary rule amendment is listed in Annex "C"

Noted for Rule Book 2013 – bring it forward 2011

23 Chairman of Jury Reports:

It was agreed that a template be drafted and distributed.

Noted

24 Plastic Wads:

Serious concern was expressed about environmental concerns. Mr. Ghelfi agreed to approach several cartridge manufacturers.

Noted

25 Rule Errors:

All listed in Annex "C"

done

26 Assistant Referees:

It was agreed t a Coach could not be a substitute if there was shooter of the same nation in the squad.

done

ISSF SHOTGUN COMMITTEE Meeting Monday 9th November 2009

Present:

Chairman:	Mr.	Demetris LORDOS	CYP
	Mr.	Bhatakarka BUNNAG	THA
	Mrs	Elaine FORWARD	AUS

Mr.	Daniele GHELFI	ITA
Mr.	James McDANIEL	USA
Mr.	Keith MURRAY	GBR
Mr.	Mohamed WAHDAN	EGY

and part time (6) 4 members of the ISSF Athletes Committee

The Chairman resumed the meeting at 08.59

27. Rule 9.2.2.1 Gun Safety Check:

It was agreed that point 8 of this rule be enforced. Mr. MacDaniel offered to write up the necessary documentation for the ISSF website and for the various technical meetings at each event in 2010.

Noted

28. Rule 6.3.22.7 Skeet House Colored Lamps:

It was agreed that both lamps must be of the same color. Rule to be amended for 2013

Noted for Rule Book 2013 – bring it forward 2011

Signed.....

Demetris F.Lordos,
Chairman
ISSF SHOTGUN COMMITTEE

Annex "A"

SKEET TARGET SETTING

SKEET:

The following procedure should be followed:-

Set Low house target to travel 66m ±1m through the centre 1/3rd of the ring

Set High house to cross the Low house target at the centre* of the ring and above the Low house target

* Tolerance minus 15cms

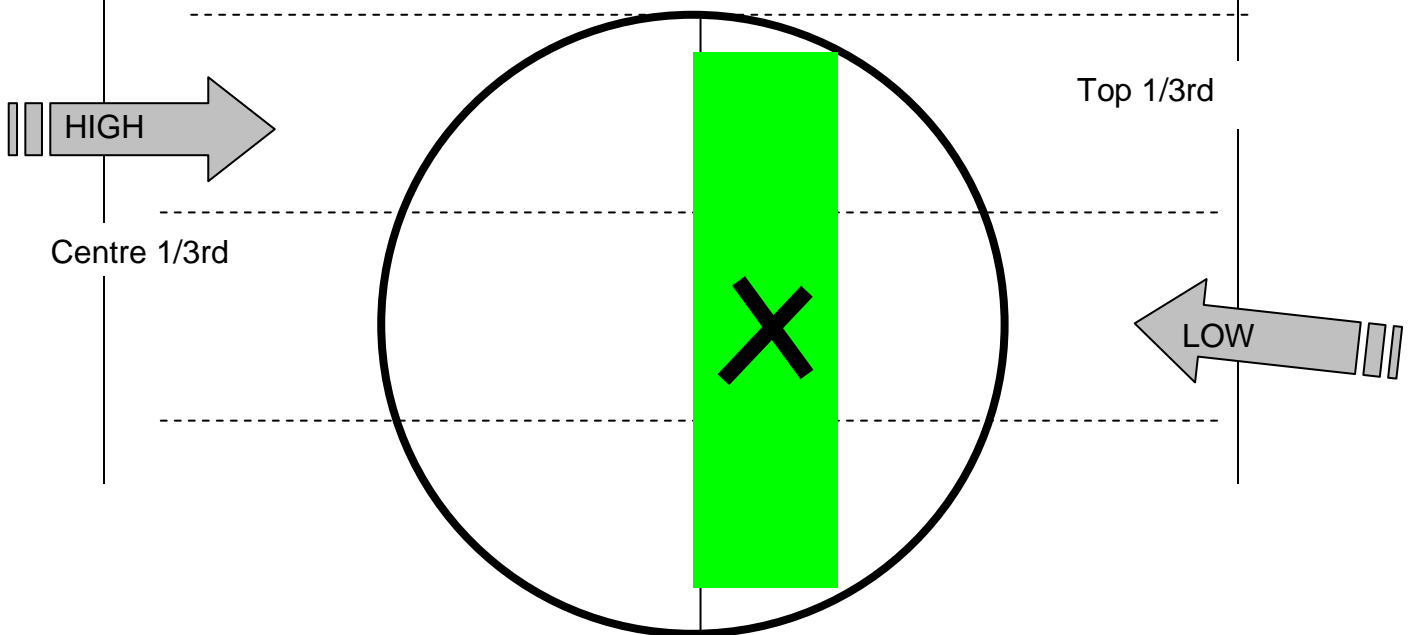

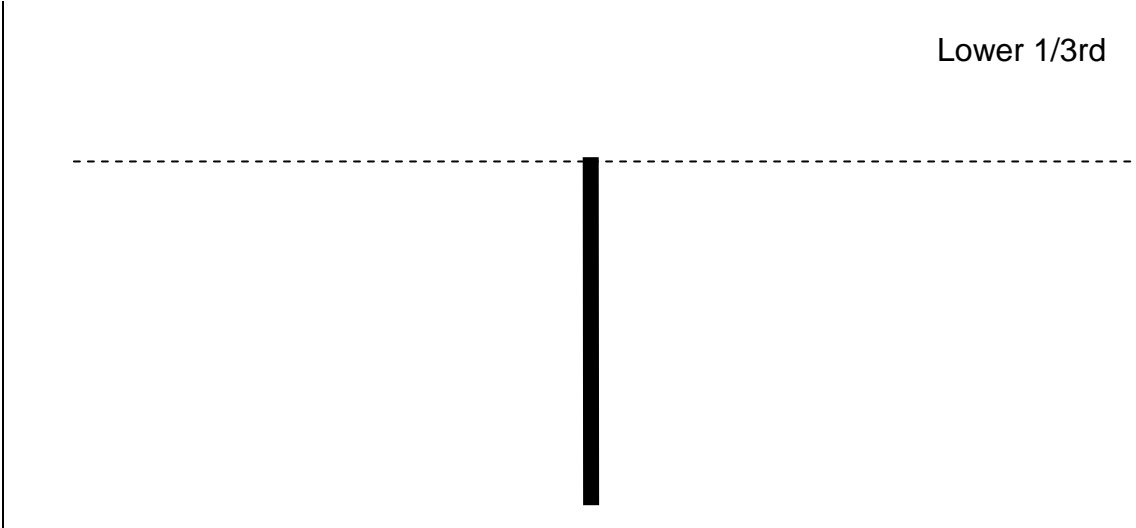

HOW TO PLACE THE ISSF OFFICIAL SKEET MARKER TAPE ON YOUR SHOOTING VEST



1. To aid the Referee in controlling the position of the shotgun the ISSF Official Marker Tape must be permanently affixed to the appropriate side of the shooting vest. The competition Jury will implement a program during the hours of pre-event training to check the position of all competitors' Official Marker Tapes. The correct position of the Tape is important to passing this inspection and allowing the shooter to have a quick and smooth gun mount.



2. Prepare a thin flat board made of cardboard or other similar material. The board should be at least 30 cm (12 inches) square. Rub a piece of white or colored chalk along one of the edges. The buildup of chalk on this edge will allow you to leave an erasable mark on the shooting vest showing the correct position of the Tape.



Rules Amendments

Annex "C"

ERRATA [Delete RED Insert GREEN] as at 9th November 2009

Rule 9.4.2.7 Ported Barrels and Ported Interchangeable Chokes

- Ported barrels are permitted provided they do not extend back further than **15 cm** **20 cm** as measured from the end of the muzzle.
- Ported interchangeable chokes are permitted, provided their porting plus any barrel porting does not exceed **15 cm** **20 cm** as measured from the muzzle end of the interchangeable fitted choke.

Noted for Rule Book 2013 – bring it forward 2011

Rule 9.6.2.1 Pre-Event Training

- must be provided for each event the day before the commencement of the official competition on the same ranges and same make and color of targets as are to be used in the official competition
- all such training must be scheduled fairly between those **Nations** **shoot-**
ers present in order that no advantage is given

done

Rule 9.11.3.3 ~~Electronic Visible~~ Scoreboard Errors

If at any stage the ~~electronic visible~~ scoreboard should display an incorrect score, the Referee must stop the shooting and with minimum delay take whatever action is required to correct it.

done

Rule 9.11.3.1

If for any reason, it is not possible to correct ~~the~~ **an electronic** display, the following action will be taken

done

9 Running Target

ISSF
Running Target Committee Meeting
November 8th and 9th 2009
Munich, Germany

Present Members

Mr. Pekka Kuusisto, FIN, Chairman
Mr. Kwan Choon Lee, KOR
Mr. Premysl Mrnak, CZE
Mr. Claes Johansson, SWE
Mr. Marc Heyer, AUT
Mr. Michael Jakosits, GER

Absent Members

Mrs. Renate Koch, GER
Mr. Igor Sokolov, RUS

Welcome

The Chairman, Mr. Pekka Kuusisto, welcomed the members of the Committee.

Meeting Secretary

The Committee appointed Mr. Jakosits to be Meeting Secretary.

Minutes of the last meeting

...were shortly discussed and accepted

Report from ISSF Council Meeting by Pekka Kuusisto

32 members were present in the meeting.

New ISSF Member Federations are Myanmar and Nigeria.

The ISSF accepted the equipment from Sius-Ascor for all 10, 25, 50 and 300 m events, equipment from Megalink and Polytronic for 10 and 50m, Meyton for 50m events. **Noted Meyton is not approved!**

Disag and Spieth equipment is still not approved for ISSF competitions.

There will be no changes for present rules before OG London 2012.

Preparations for WCH 2010 in Munich are on schedule.

Report from ISSF Running Target WCH 2009

Both the Executive Committee and Administrative Council of the ISSF granted provisional WCH for Running Target in their meetings in April 2009.

The Finnish Sport Shooting Federation took the challenge and promised to arrange competitions in Heinola / FIN in the end of August.

69 shooters from 13 countries participated with a total of 192 starts. With the exception of the women category there had been enough shooters to arrange individual and team competitions.

Transportation was well organised from Helsinki by busses and minibusses. All delegations arrived during two days which made transportation quite easy. The delegations also stayed together in the shooting range area so no further transportation was needed.

The Vierumäki shooting range had three ranges for 10m and one range for 50m. All of them were electronic targets and very experienced staff made the competitions comfortable. The staff of competitions was 15 persons on the ranges and 7 in competitions office.

A new world record was set by the Russian junior team in 10m with 1702 points (old WR 1698 p.). Maxim Stepanov, RUS, equalled the long lasting WR in the 50m event with 596 points.

No protests were made and all shooters and team officials were satisfied for arrangements.

The MedalMatches in men and women 10m events attracted a full hall of spectators as well as press people from Finnish newspapers and reporters from ISSF NEWS.

Hopefully this procedure of separate WCH for Running Target can continue and attract more nations to participate once again.

Experiences with MedalMatch and proposals for rules change

Proposals for modification of Running Target rules :

- 1 50 m target from running boar to "dots"

The Committee decided not to change the 50m target, because there is no increase in number of shooters expected. In most countries the 50m boar target has strong support from hunting and a change of target could be a risk to loose shooters.

2 free scope magnification and free length of scope

The Committee discussed the proposal and decided to gather more information from nations and shooters. The Committee is positive about cancelling the restriction in scope length but not in magnification.

A decision will be made in the next meeting in 2010.

Agreed concerning no restriction in the length. Therefore the restriction is cancelled with immediate effect.

3 No point from equal result in Medal Match

The Committee agreed to the proposal and makes a suggestion to the Technical Committee for a rule change.

Noted - goes into the errata

4 Two points difference between Winner and Looser in Medal Match
Regarding a quick and short decision the Committee denies the proposal. The Medal Match might then take too long. In other shooting events we have also only one shot e.g. for breaking ties.

The following E-Mail was send to the Chairman of the RT.
Munich, 09.11.2009

Dear Pekka!

The Technical Committee questions the point 4 of your experiences with the Medal Match.

That "the Medal Match might then take too long" if there is a two (2) point difference between winner and loser in the Medal Match.

The Committee would be interested in an explanation as to why your committee has made this decision as it is believed that the media and others have a different opinion.

Has it been taken into account the RT procedure with left and right runs?

Best regards

David Parish
Chairman ISSF Technical Committee.

Modification of 50m Running Target

The Committee decided that no modifications are needed.

Noted

Rest noted

World Championships in 2011 / 2012

The Committee discussed the sites for carrying out the championships. Slovakia or Hungary for the WCH in 2011, Stockholm / SWE for 2012.

The Committee decided to officially enquire the named federations for their support in arranging WCH in Running Target.
The Chairman, Mr. Pekka Kuusisto, will inform the federations. Deadline for information to the committee should be March 30th 2010 in order to reach a decision by ISSF Executive Committee in 2010.

Improvement of work of RT Committee

Create an international database of competitions and distribute it to member federations.

Special attention e.g. for the online shooting competition "Austria Cup" and the online competition of Ukrainian Shooting Federation.

The Committee wants to investigate the possibility for Running Target of participating in the World Games.

Regular meetings with coaches and shooters during international competitions like in the past years.

Situation of RT in different countries

The situations in different parts of the world were discussed.
There are some special activities in Asia (10 nations known to shoot RT).
In Europe the situation is quite stable. Some older shooters have stopped their activities but there are a lot of young shooters coming up.

Any other business

The Committee supports the online match from the Austrian Shooting Federation in Running Target 10m "Int. RT Austria Cup 2010". Website : www.marc.lha.at from Jan. 1st 2010.

The Committee also asks the ESC and ISSF for support of this match by establishing a weblink on the homepages.

Michael Jakosits
Secretary

Pekka Kuusisto
Chairman

10 Athletes Committee

MINUTES OF THE MEETING OF THE ATHLETES COMMITTEE HELD ON THE 8TH AND 9TH NOVEMBER 2009 AT HOTEL HILTON, MUNICH PARK

Present:

Juha Hirvi – Chairman
Susanne Kiermayer
Yifu Wang
Moraad a Khan

Absent:

Audrey Corenflos
Jason Parker

The Chairman welcomed all present for the meeting and requested Mr. Moraad a Khan to act as the Secretary for the meeting.

Given below are some of the earlier action points where we have not received

the feedback on action taken:

- The Committee discussed the issue of formation of the Athletes Committee of various affiliated continental and national federations with the Secretary General. It was agreed that a suitable circular would be sent to all the affiliated member federations and respective continental federations to form the Athletes Committee. In case some of the federations do not react then another letter will be given at the Munich world cup in 2009 Championship 2010.

Action: ISSF Headquarters during the Munich World Championship.

Send a proposal to the ISSF HQ for further action.

- At present the shooter on station no: 1 has to wait for the shooter at station no: 5 to walk up before the referee gives that command to him to shoot. It was recommended that this wait rule should apply after all the six shooters in the finals have finished one string of shots. This will help the commentators to give more meaningful comments and the spectator to enjoy the game more rather than getting into mathematical calculations on the scores.

**Action: ISSF Headquarters
Technical Committee
Shotgun Committee**

Forward it first to the ISSF TV and then to the Shotgun Committee.

- The committee agreed on the suggestion of ISSF TV to put wireless laser on the rifle barrel which could be seen on the TV to make more interesting viewing. Appropriate weight needs to be added to the barrel during practice to compensate for the laser during the finals.

**Action: ISSF Headquarters
Technical Committee
Rifle Committee
ISSF TV**

The ISSF Technical Committee appreciates this proposal. Some test must be made.

- In order to get immediate response from the winners it is suggested to put the score on the shooters monitor in the Rifle and Pistol finals.
Consider also ties and protests.

**Action: ISSF Headquarters
Technical Committee
Pistol Committee
Rifle Committee
ISSF TV**

- We should try to mount a small wireless camera under the shotgun barrel as an experiment to get the shooters 'POINT OF VIEW' for the ISSF TV.

**Action: ISSF Headquarters
Technical Committee
ISSF TV**

The ISSF Technical Committee appreciates this proposal. Some test must be made.

- In case the quota place is to be awarded to a shooter out of the finals then it should be decided on a shoot off in all events if there is a tie on the same score.

Action: ISSF Headquarters
Denied

Given below are the fresh proposals discussed during the meeting:

- The committee after due deliberations felt that it would be appropriate to have the World Cup finals event within six weeks of the last qualifying championship competition.

Action: ISSF Headquarters
See Explanation of the ISSF Secretary General during meeting and workshop

- Appropriate guidelines to be issued by the ISSF Headquarters to all the member federation to implement the correct dress code during the shooting competitions to ensure that the shooters give the look and feel of an Olympic athlete.

Action: ISSF Headquarters
The ISSF Technical Committee appreciates this proposal.

- Any kind of major changes in the shooting rules should be implemented almost immediately after the Olympic Games. Changes taking place after a considerable delay are detrimental to the athlete's preparation for the Olympic Games and we do not agree to make such changes.

Action: ISSF Headquarters
See Rule 6.1.1.4.

- In the constitution of the athletes committee when the nominations are received from the National federations, it is imperative the ISSF asks to nominate only those athletes who can communicate in English to have better and fruitful discussions during the meetings.

Action: ISSF Headquarters
Noted

- In case the selected / elected athletes are not able to attend the meetings of the athletes committee for some inevitable reasons the ISSF should replace such members from those other athletes who have lost in the elections.

Action: ISSF Headquarters
Noted

- We had deliberations with the shotgun committee on the future of double trap. Our committee desired that all the three different double trap variations should be tried during the Lonato World cup. Trying all the three variations will help in getting a comparative feedback. Our committee also proposed that a suitable marketing company be hired to look into the possibility of replacing double trap with an event, which is spectator friendly and would generate a lot of revenue for the sport. The

information of any change should be immediately conveyed to the shooters so that they can plan their careers accordingly.

Action: ISSF Headquarters

**Technical Committee
Shotgun Committee**

- Youth Olympic Games were discussed and our committee was very disappointed to hear that those born in the year 1994/95 will not be allowed to take part in these games. We felt that is a case of discrimination against half the youth population of the world.

Noted

- On a request from ISSF TV it was agreed by our committee that if remote controlled camera were installed in front of the shooting stations in clay target event it would not be a distraction to shooters. Such cameras should be installed not closer than 2 meters from the shooting stations.

Noted

- The athletes committee decided to have a Facebook page for better communication with all ISSF athletes.

Noted

Action: Moraad A Khan

Mr. Horst Schreiber

Secretary General
ISSF
Munich

9th Nov'09

Dear Mr. Schreiber,

Please find enclosed the minutes of the Athlete's Committee meeting held at Hotel Holiday Inn, Munich on the 8th and 9th November'2009.

We have had some very fruitful interaction with you, as well as the members of other committees during these couple of days here. We have made certain suggestions with the sole idea of development of our sports and attracting youngsters to take up our sports for its success. The guidance, which we received from all the members of other relevant committees, was very helpful in firming up our recommendations. Trust that our contributions in thought and actions will be useful.

Kind Regards

Yours sincerely

(JuhaHirvi)(Susanne Kiermayer)

(Yifu Wang)(Moraad Ali Khan)

Copy to:

	Chairman, Technical Committee Chairman, Rifle Committee Chairman, Pistol Committee Chairman, Shotgun Committee Chairman, Medical Committee ISSF TV
11	Miscellaneous Some Rule amendments and corrections were done See Errata from the ISSF Technical Committee20091110.doc

WITHIN THE YEAR 2009

ALL ISSF WORLD RECORDS and ISSF FINAL WORLD RECORDS
dated October 26 2009

MEN

EVENTS:

300m Rifle 3 Positions Men

WR			1184	SIDI, Peter; HUN	25.07.2009	ECH Osijek
----	--	--	------	------------------	------------	------------

25m Center Fire Pistol Men:

EWR			594	KLIMOV, Alexei; RUS	25.07.2009	ECH Osijek
-----	--	--	-----	---------------------	------------	------------

10m Air Pistol Men:

WR			594	JIN, Jong Oh; KOR	12.04.2009	WC Changwon
----	--	--	-----	-------------------	------------	-------------

50m Running Target Men:

EWR			596	STEPANOV, Maxim; RUS	29.08.2009	WCH Heinola
-----	--	--	-----	----------------------	------------	-------------

Trap Men:

EWR			125	FABBRIZI, Massimo; ITA	15.05.2009	WC Munich
-----	--	--	-----	------------------------	------------	-----------

Double Trap

Men:

FWR			196 (147+49)	HU, Binyuan; CHN	10.06.2009	WC Minsk
EWR			147	HU, Binyuan; CHN	10.06.2009	WC Minsk
EWR		T	430	HOLGUIN, Jeffrey; RICHMOND, Joshua; ELLER, Walton; USA	13.08.2009	WCH Maribor

Skeet Men:

EFWR			150 (125+25)	BROVOLD, Tore; NOR	25.07.2009	ECH Osijek
EWR			125	MILCHEV, Mikola; UKR	09.05.2009	WC Cairo
EWR			125	SYCHRA, Jan; CZE	20.05.2009	WC Munich
EWR			125	BROVOLD, Tore; NOR	25.07.2009	ECH Osijek
WR		T	366	HANCOCK, Vincent; DULOHERY, Shawn; THOMPSON, Frank; USA	16.08.2009	WCH Maribor

WOMEN EVENTS:

300m Rifle Prone Women:

WR			599	JAKOBSEN, Charlotte; DEN	21.07.2009	ECH Osijek
----	--	--	-----	--------------------------	------------	------------

10m Air Rifle Women:

EWR			400	WU, Liuxi; CHN	26.10.2009	WCF Wuxi
-----	--	--	-----	----------------	------------	----------

Trap Women:

EWR			74	MAKELA-NUMMELA, Satu; FIN	11.08.2009	WCH Maribor
WR		T	211	ROSSI, Jessica; GELISIO, Deborah; IANNOTTI, Giulia; ITA	11.08.2009	WCH Maribor

Skeet Women:

EWR			74	JIEWCHALOEMMIT, Sutiya; THA	08.05.2009	WC Cairo
EWR			74	WEI, Ning; CHN	19.05.2009	WC Munich

MEN JUNIOR EVENTS:

50m Rifle 3 Positions Men Junior:

WRJ	J		1182	HE, Zhaohui; CHN	20.05.2009	WC Munich
-----	---	--	------	------------------	------------	-----------

10m Air Rifle Men Junior:

EWRJ	J		599	RIKHTER, Sergy; ISR	16.05.2009	WC Munich
------	---	--	-----	---------------------	------------	-----------

10m Air Pistol Men Junior:

EWRJ	J		588	GRUNDER, Lukas; SUI	24.05.2009	WC Milan
------	---	--	-----	---------------------	------------	----------

10m Running Target Men Junior:

WRJ	J	T	1702	AZARENKO, Mikhail; NAUMENKO, Alexander; DOVGAL, Yuri; RUS	25.08.2009	WCH Heinola
-----	---	---	------	---	------------	-------------

WOMEN JUNIOR EVENTS:

50m Rifle Prone Women Junior:

WRJ	J	T	1771	SAEKER, Hanna; BENGTSSON, Erika; KARLSSON, Elin; SWE	14.07.2009	ECH Osijek
-----	---	---	------	--	------------	------------

Trap Women Junior:

WRJ	J	T	193	CANTARERO, Karina; CLEMENTE, Eva Maria; DIAZ, Aitana;	17.07.2009	ECH Osijek
WRJ	J	T	202	QI, Qiuwen; XU, Tian; WANG, Yajun; CHN	11.08.2009	WCH Maribor

Skeet Women Junior:

WRJ	J		74	LUNDQVIST, Therese; SWE	11.08.2009	WCH Maribor
WRJ	J	T	204	ENGLISH, Amber; CHIANG, Alexander; CONNER, Caitlin; USA	11.08.2009	WCH Maribor

Munich,09./10.11.2009

David Parish, Chairman ISSF Technical Committee